

■ 1. Wine (Sul-R:1312)

**Redwork Sewing 01 4x4.dst**  
3.91x3.14 inches; 4,916 stitches  
1 thread changes; 1 colors

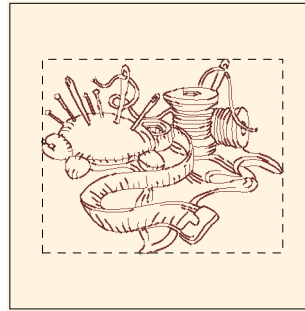

■ 1. Wine (Sul-R:1312)

**Redwork Sewing 01 5x7.dst**  
6.19x4.99 inches; 7,115 stitches  
1 thread changes; 1 colors

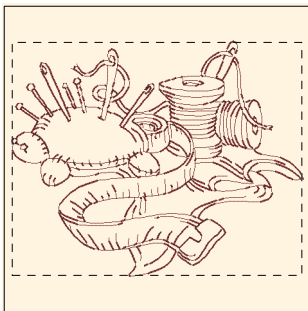

■ 1. Wine (Sul-R:1312)

**Redwork Sewing 01 6x10.dst**  
7.46x6.00 inches; 8,243 stitches  
1 thread changes; 1 colors

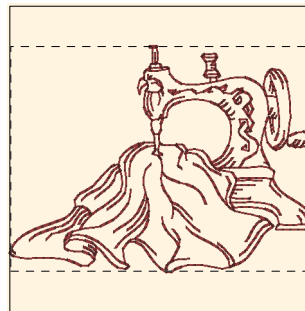

■ 1. Wine (Sul-R:1312)

**Redwork Sewing 02 4x4.dst**  
3.91x2.89 inches; 3,327 stitches  
1 thread changes; 1 colors

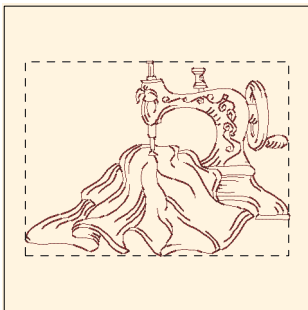

■ 1. Wine (Sul-R:1312)

**Redwork Sewing 02 5x7.dst**  
6.78x5.00 inches; 5,260 stitches  
1 thread changes; 1 colors

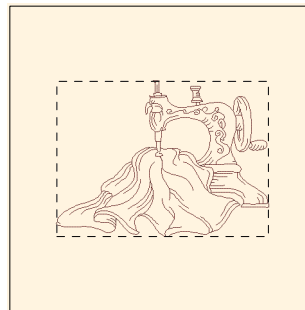

■ 1. Wine (Sul-R:1312)

**Redwork Sewing 02 6x10.dst**  
8.17x6.00 inches; 6,114 stitches  
1 thread changes; 1 colors

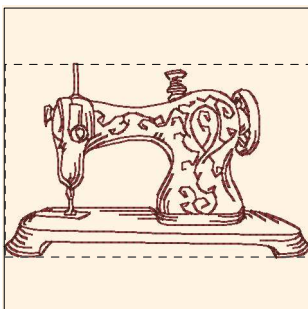

■ 1. Wine (Sul-R:1312)

**Redwork Sewing 03 4x4.dst**  
3.91x2.48 inches; 3,484 stitches  
1 thread changes; 1 colors

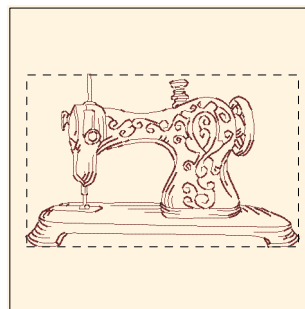

■ 1. Wine (Sul-R:1312)

**Redwork Sewing 03 5x7.dst**  
7.00x4.43 inches; 5,665 stitches  
1 thread changes; 1 colors

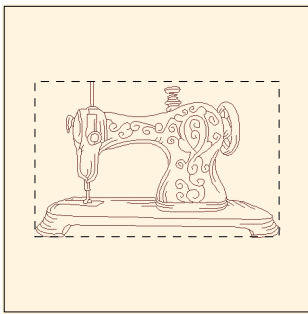

■ 1. Wine (Sul-R:1312)

**Redwork Sewing 03 6x10.dst**  
9.43x5.99 inches; 7,279 stitches  
1 thread changes; 1 colors

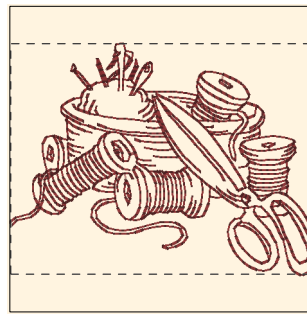

■ 1. Wine (Sul-R:1312)

**Redwork Sewing 04 4x4.dst**  
3.91x2.97 inches; 4,966 stitches  
1 thread changes; 1 colors

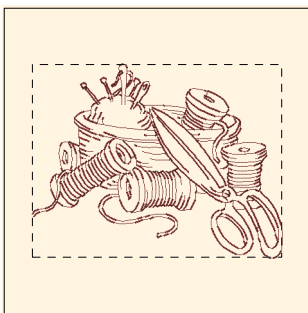

■ 1. Wine (Sul-R:1312)

**Redwork Sewing 04 5x7.dst**  
6.43x4.96 inches; 7,674 stitches  
1 thread changes; 1 colors

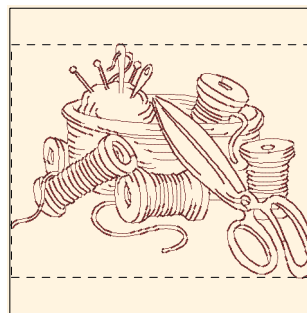

■ 1. Wine (Sul-R:1312)

**Redwork Sewing 04 6x10.dst**  
7.78x5.99 inches; 8,888 stitches  
1 thread changes; 1 colors

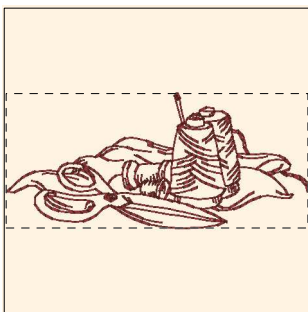

■ 1. Wine (Sul-R:1312)

**Redwork Sewing 05 4x4.dst**  
3.89x1.74 inches; 2,846 stitches  
1 thread changes; 1 colors

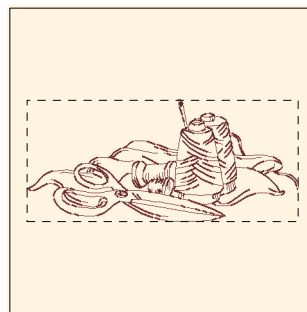

■ 1. Wine (Sul-R:1312)

**Redwork Sewing 05 5x7.dst**  
6.98x3.13 inches; 4,538 stitches  
1 thread changes; 1 colors

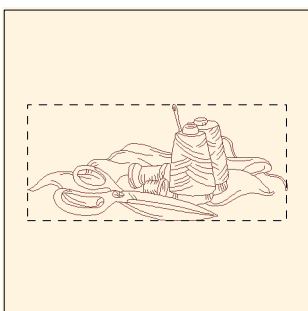

■ 1. Wine (Sul-R:1312)

**Redwork Sewing 05 6x10.dst**  
10.00x4.48 inches; 6,124 stitches  
1 thread changes; 1 colors



■ 1. Wine (Sul-R:1312)

**Redwork Sewing 06 4x4.dst**  
3.91x3.59 inches; 4,358 stitches  
1 thread changes; 1 colors



■ 1. Wine (Sul-R:1312)

**Redwork Sewing 06 5x7.dst**  
5.46x4.99 inches; 5,800 stitches  
1 thread changes; 1 colors



■ 1. Wine (Sul-R:1312)

**Redwork Sewing 06 6x10.dst**  
6.54x5.99 inches; 6,795 stitches  
1 thread changes; 1 colors

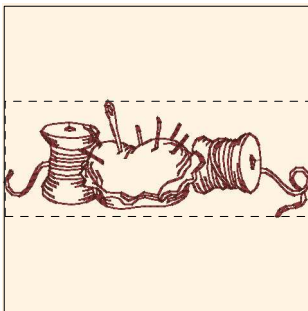

■ 1. Wine (Sul-R:1312)

**Redwork Sewing 07 4x4.dst**  
3.91x1.48 inches; 2,609 stitches  
1 thread changes; 1 colors

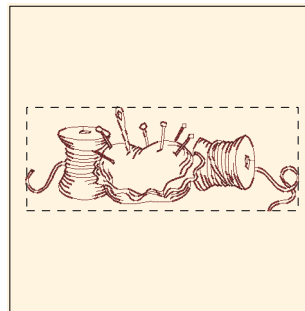

■ 1. Wine (Sul-R:1312)

**Redwork Sewing 07 5x7.dst**  
6.99x2.67 inches; 4,221 stitches  
1 thread changes; 1 colors

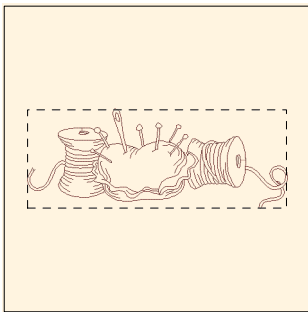

■ 1. Wine (Sul-R:1312)

**Redwork Sewing 07 6x10.dst**  
9.99x3.81 inches; 5,842 stitches  
1 thread changes; 1 colors

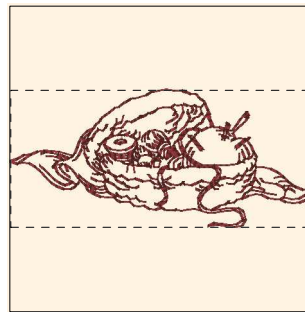

■ 1. Wine (Sul-R:1312)

**Redwork Sewing 08 4x4.dst**  
3.91x1.77 inches; 3,712 stitches  
1 thread changes; 1 colors

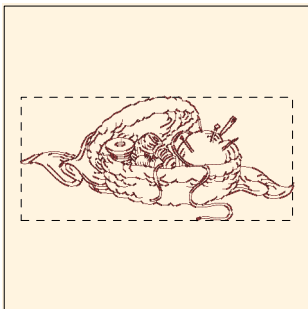

■ 1. Wine (Sul-R:1312)

**Redwork Sewing 08 5x7.dst**  
6.99x3.17 inches; 5,651 stitches  
1 thread changes; 1 colors

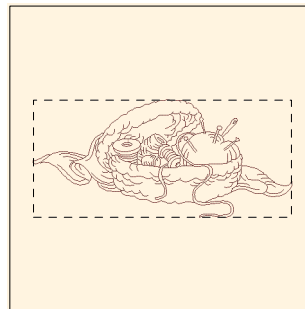

■ 1. Wine (Sul-R:1312)

**Redwork Sewing 08 6x10.dst**  
9.96x4.53 inches; 7,331 stitches  
1 thread changes; 1 colors

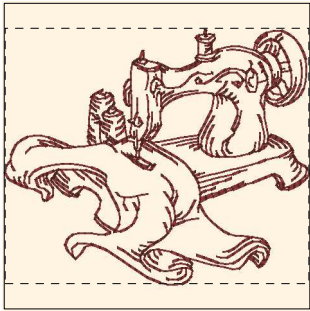

■ 1. Wine (Sul-R:1312)

**Redwork Sewing 09 4x4.dst**  
3.91x3.30 inches; 4,894 stitches  
1 thread changes; 1 colors

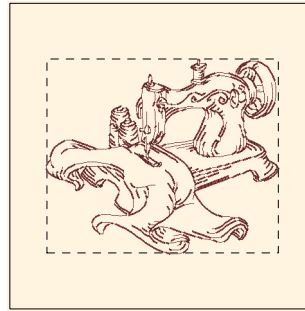

■ 1. Wine (Sul-R:1312)

**Redwork Sewing 09 5x7.dst**  
5.96x5.00 inches; 6,799 stitches  
1 thread changes; 1 colors

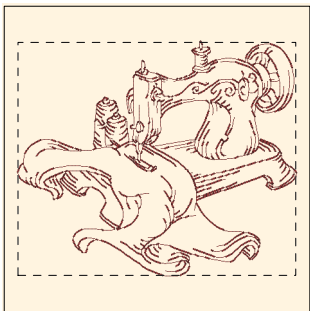

■ 1. Wine (Sul-R:1312)

**Redwork Sewing 09 6x10.dst**  
7.15x6.00 inches; 7,843 stitches  
1 thread changes; 1 colors

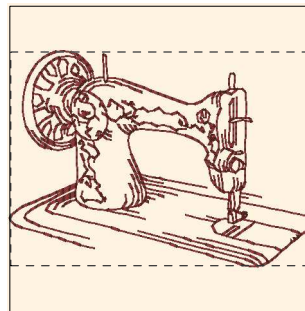

■ 1. Wine (Sul-R:1312)

**Redwork Sewing 10 4x4.dst**  
3.91x2.75 inches; 3,962 stitches  
1 thread changes; 1 colors

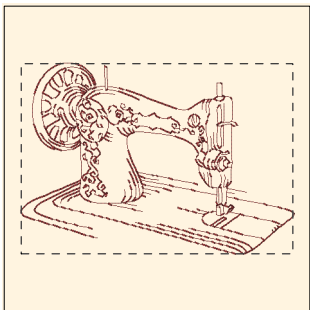

■ 1. Wine (Sul-R:1312)

**Redwork Sewing 10 5x7.dst**  
7.00x4.90 inches; 6,416 stitches  
1 thread changes; 1 colors

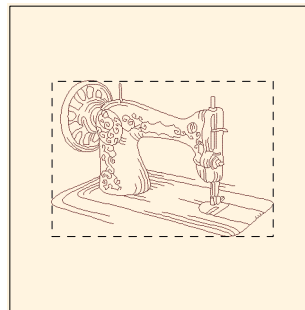

■ 1. Wine (Sul-R:1312)

**Redwork Sewing 10 6x10.dst**  
8.54x5.99 inches; 7,749 stitches  
1 thread changes; 1 colors