

- 1. Sapphire (Sul-R:1534)
- 2. Bright White (Sul-R:1001)
- 3. Sapphire (Sul-R:1534)

Alpha.dst
2.83x2.74 inches; 2,203 stitches
3 thread changes; 2 colors

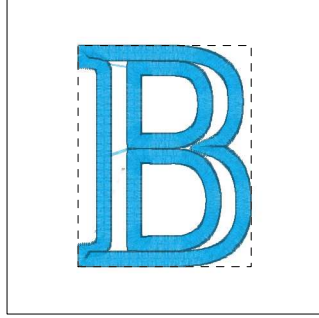

- 1. Duck Wing Blue (Sul-R:1250)
- 2. Bright White (Sul-R:1001)
- 3. Duck Wing Blue (Sul-R:1250)

Beta.dst
2.16x2.76 inches; 2,985 stitches
3 thread changes; 2 colors

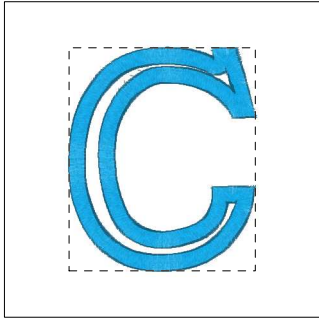

- 1. Duck Wing Blue (Sul-R:1250)
- 2. Bright White (Sul-R:1001)
- 3. Duck Wing Blue (Sul-R:1250)

Gamma.dst
2.33x2.78 inches; 2,242 stitches
3 thread changes; 2 colors

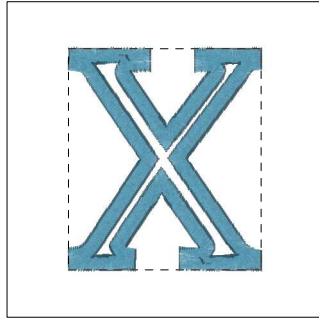

- 1. Med. Weathered Blue (Sul-R:1172)
- 2. Bright White (Sul-R:1001)
- 3. Med. Weathered Blue (Sul-R:1172)

Chi.dst
2.41x2.76 inches; 2,428 stitches
3 thread changes; 2 colors

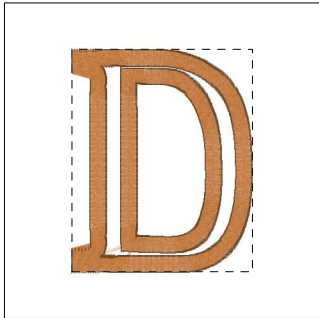

- 1. Tan (Sul-R:1126)
- 2. Bright White (Sul-R:1001)
- 3. Tan (Sul-R:1126)

Delta.dst
2.25x2.78 inches; 2,582 stitches
3 thread changes; 2 colors

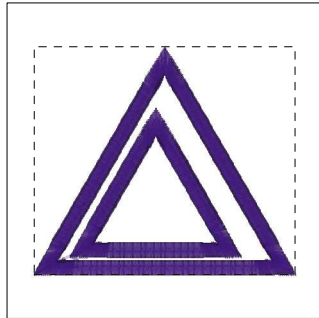

- 1. Deep Eggplant (Sul-R:1301)
- 2. Bright White (Sul-R:1001)
- 3. Deep Eggplant (Sul-R:1301)

Epsilon.dst
3.26x2.84 inches; 2,467 stitches
3 thread changes; 2 colors

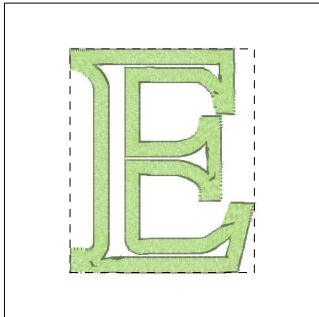

- 1. Chartreuse (Sul-R:1322)
- 2. Bright White (Sul-R:1001)
- 3. Chartreuse (Sul-R:1322)

Zeta.dst
2.31x2.79 inches; 2,662 stitches
3 thread changes; 2 colors

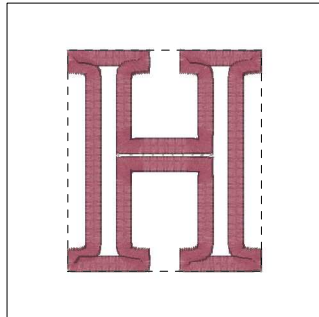

- 1. Med. Burgundy (Sul-R:1190)
- 2. Bright White (Sul-R:1001)
- 3. Med. Burgundy (Sul-R:1190)

Eta.dst
2.42x2.76 inches; 3,015 stitches
3 thread changes; 2 colors

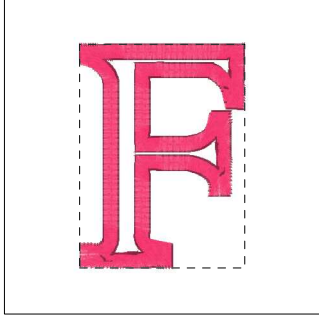

- 1. Petal Pink (Sul-R:1307)
- 2. Bright White (Sul-R:1001)
- 3. Petal Pink (Sul-R:1307)

F.dst
2.06x2.79 inches; 2,126 stitches
3 thread changes; 2 colors

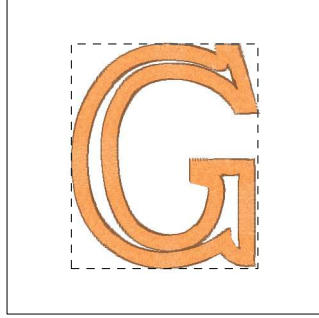

- 1. Apricot (Sul-R:1239)
- 2. Bright White (Sul-R:1001)
- 3. Apricot (Sul-R:1239)

G.dst
2.33x2.80 inches; 2,474 stitches
3 thread changes; 2 colors

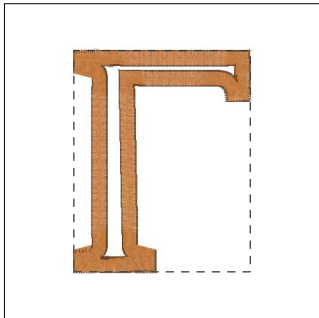

- 1. Tan (Sul-R:1126)
- 2. Bright White (Sul-R:1001)
- 3. Tan (Sul-R:1126)

Gamma.dst
2.20x2.76 inches; 1,703 stitches
3 thread changes; 2 colors

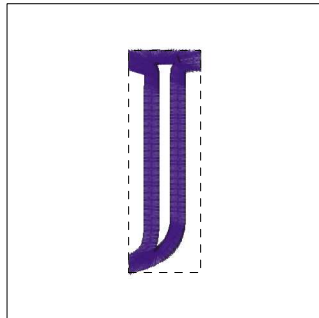

- 1. Deep Eggplant (Sul-R:1301)
- 2. Bright White (Sul-R:1001)
- 3. Deep Eggplant (Sul-R:1301)

J.dst
0.90x2.77 inches; 1,085 stitches
3 thread changes; 2 colors

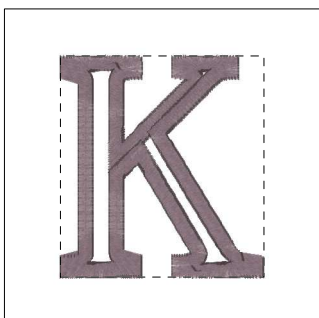

- 1. Dk. Taupe (Sul-R:1179)
- 2. Bright White (Sul-R:1001)
- 3. Dk. Taupe (Sul-R:1179)

Kappa.dst
2.54x2.76 inches; 2,628 stitches
3 thread changes; 2 colors



- 1. (Sul-R:1314)
- 2. Bright White (Sul-R:1001)
- 3. (Sul-R:1314)

L.dst
2.26x2.78 inches; 1,742 stitches
3 thread changes; 2 colors

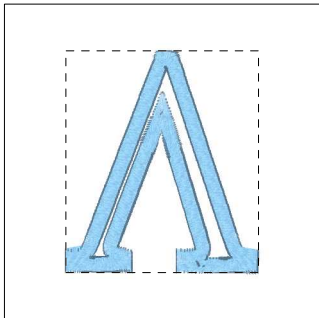

- 1. Cornflower Blue (Sul-R:1249)
- 2. Bright White (Sul-R:1001)
- 3. Cornflower Blue (Sul-R:1249)

Lambda.dst
2.41x2.77 inches; 1,916 stitches
3 thread changes; 2 colors

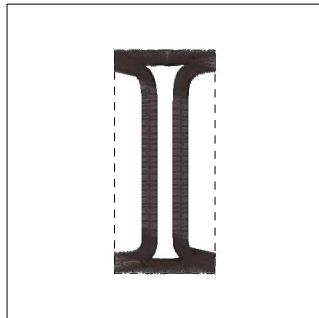

- 1. Blackberry (Sul-R:1215)
- 2. Bright White (Sul-R:1001)
- 3. Blackberry (Sul-R:1215)

Lota.dst
1.26x2.78 inches; 1,249 stitches
3 thread changes; 2 colors

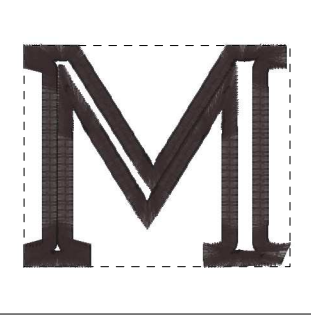

- 1. Blackberry (Sul-R:1215)
- 2. Bright White (Sul-R:1001)
- 3. Blackberry (Sul-R:1215)

Mu.dst
3.32x2.76 inches; 3,350 stitches
3 thread changes; 2 colors

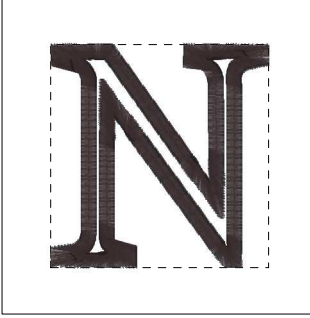

- 1. Blackberry (Sul-R:1215)
- 2. Bright White (Sul-R:1001)
- 3. Blackberry (Sul-R:1215)

Nu.dst
2.72x2.78 inches; 2,783 stitches
3 thread changes; 2 colors

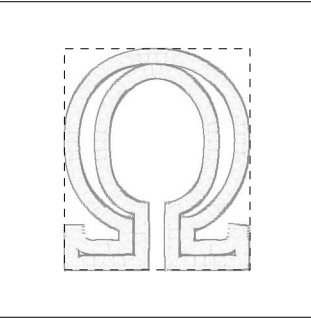

- 1. Bright White (Sul-R:1001)
- 2. (Sul-R:610)
- 3. Bright White (Sul-R:1001)

Omega.dst
2.32x2.76 inches; 2,977 stitches
3 thread changes; 2 colors

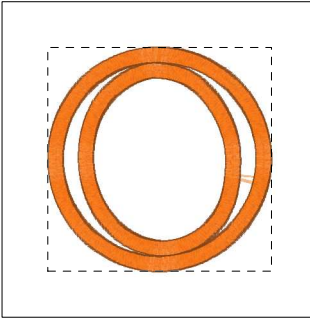

- 1. (Sul-R:1314)
- 2. Bright White (Sul-R:1001)
- 3. (Sul-R:1314)

Omicron.dst
2.79x2.79 inches; 2,681 stitches
3 thread changes; 2 colors

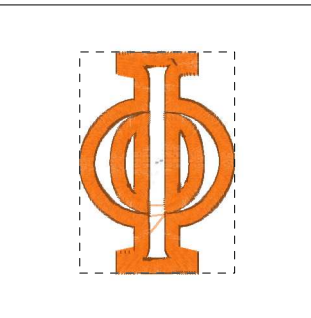

- 1. (Sul-R:1314)
- 2. Bright White (Sul-R:1001)
- 3. (Sul-R:1314)

Phi.dst
1.94x2.76 inches; 2,361 stitches
3 thread changes; 2 colors

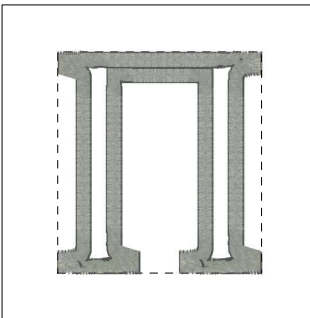

- 1. (Sul-R:610)
- 2. Bright White (Sul-R:1001)
- 3. (Sul-R:610)

Pi.dst
2.55x2.76 inches; 2,644 stitches
3 thread changes; 2 colors

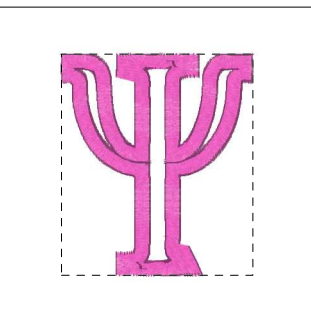

- 1. Hot Pink (Sul-R:1109)
- 2. Bright White (Sul-R:1001)
- 3. Hot Pink (Sul-R:1109)

Psi.dst
2.39x2.76 inches; 2,468 stitches
3 thread changes; 2 colors

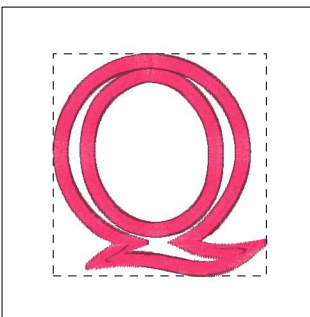

- 1. Petal Pink (Sul-R:1307)
- 2. Bright White (Sul-R:1001)
- 3. Petal Pink (Sul-R:1307)

Q.dst
2.66x2.77 inches; 2,589 stitches
3 thread changes; 2 colors

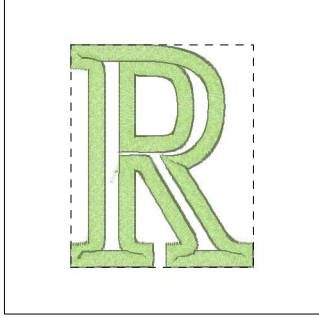

- 1. Chartreuse (Sul-R:1322)
- 2. Bright White (Sul-R:1001)
- 3. Chartreuse (Sul-R:1322)

R.dst
2.28x2.78 inches; 2,934 stitches
3 thread changes; 2 colors

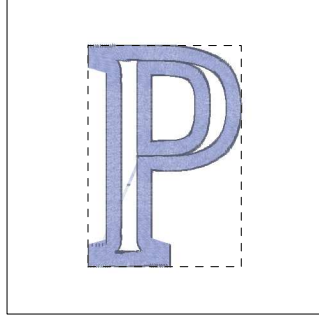

- 1. Winter Sky (Sul-R:1291)
- 2. Bright White (Sul-R:1001)
- 3. Winter Sky (Sul-R:1291)

Rho.dst
1.92x2.76 inches; 2,062 stitches
3 thread changes; 2 colors

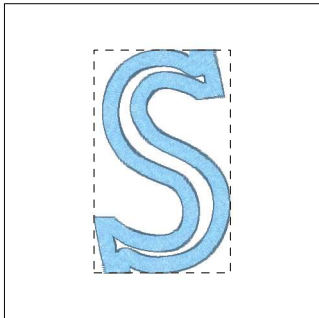

- 1. Cornflower Blue (Sul-R:1249)
- 2. Bright White (Sul-R:1001)
- 3. Cornflower Blue (Sul-R:1249)

S.dst
1.70x2.78 inches; 1,973 stitches
3 thread changes; 2 colors

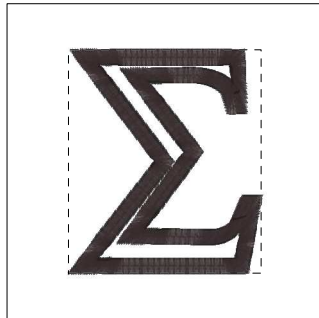

- 1. Blackberry (Sul-R:1215)
- 2. Bright White (Sul-R:1001)
- 3. Blackberry (Sul-R:1215)

Sigma.dst
2.41x2.79 inches; 2,376 stitches
3 thread changes; 2 colors

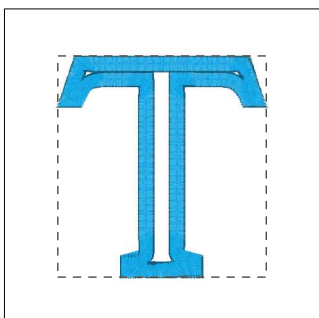

- 1. Eggplant (Sul-R:1302)
- 2. Bright White (Sul-R:1001)
- 3. Duck Wing Blue (Sul-R:1250)

Tau.dst
2.60x2.76 inches; 1,824 stitches
3 thread changes; 3 colors

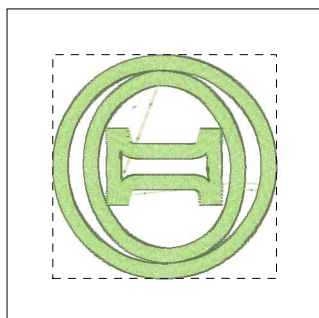

- 1. Chartreuse (Sul-R:1322)
- 2. Bright White (Sul-R:1001)
- 3. Chartreuse (Sul-R:1322)

Theta.dst
2.79x2.79 inches; 3,394 stitches
3 thread changes; 2 colors

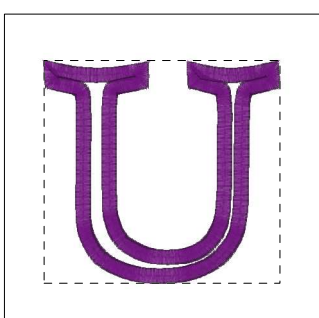

- 1. Deep Orchid (Sul-R:1255)
- 2. Bright White (Sul-R:1001)
- 3. Deep Orchid (Sul-R:1255)

U.dst
2.95x2.78 inches; 2,696 stitches
3 thread changes; 2 colors

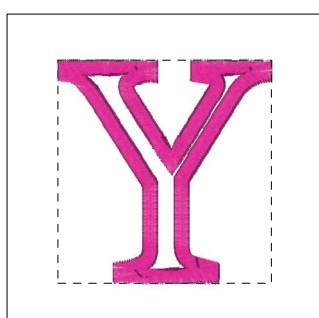

- 1. Med. Rose (Sul-R:1231)
- 2. Bright White (Sul-R:1001)
- 3. Med. Rose (Sul-R:1231)

Upsilon.dst
2.67x2.78 inches; 1,954 stitches
3 thread changes; 2 colors

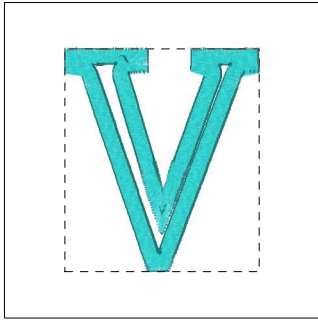

- 1. Deep Aqua (Sul-R:571)
- 2. Bright White (Sul-R:1001)
- 3. Deep Aqua (Sul-R:571)

V.dst

2.43x2.78 inches; 1,982 stitches
3 thread changes; 2 colors

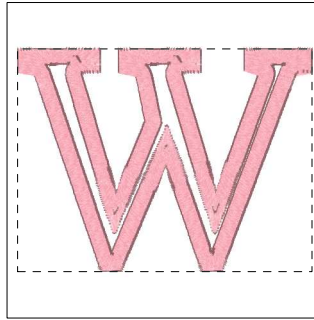

- 1. Pastel Coral (Sul-R:1016)
- 2. Bright White (Sul-R:1001)
- 3. Pastel Coral (Sul-R:1016)

W.dst

3.68x2.78 inches; 3,410 stitches
3 thread changes; 2 colors

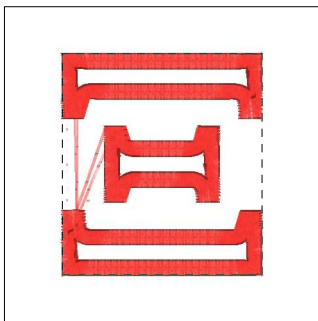

- 1. Poppy (Sul-R:1317)
- 2. Bright White (Sul-R:1001)
- 3. Poppy (Sul-R:1317)

Xi.dst

2.50x2.76 inches; 2,802 stitches
3 thread changes; 2 colors

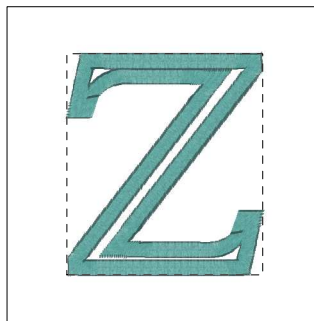

- 1. Med. Aqua (Sul-R:640)
- 2. Bright White (Sul-R:1001)
- 3. Med. Aqua (Sul-R:640)

Zeta.dst

2.45x2.76 inches; 2,582 stitches
3 thread changes; 2 colors